

## Multikonsoll för armaturer DN 100-300

Vårt nya koncept som revolutionerar monteringen och driften av ventilbrunnar



I färdiga bunnar med ingjutna skenor monteres armaturen med hjälp av tillhörande konsoller

- Enkel montering
- Standardiserade centreringshöjder
- Flexibel justering i längdriktningen

### Ett konsollsett för varje dimension

DN 100

DN 150

DN 200

DN 250

DN 300



Antal	DN	PN	Art. nr.	Konsoll	Antal pr. sett	Vikt kg/stk.
1	DN 100	PN10-16	1221	Konsollt DN100	2	6
			1220	Skena	2	16
1	DN 150	PN10-16	1222	Konsoll DN150	2	11
			1220	Skena	2	16
1	DN 200	PN10-16	1223	Konsoll DN200	2	11
			1220	Skena	2	16
1	DN 250	PN 10 (PN 16 på forespörel)	1224	Konsoll DN250	2	15
			1220	Skena	4 (2)*	16
1	DN 300	PN 10 (PN 16 på forespörel)	1225	Konsoll DN300	2	21,5
			1220	Skena	4(2)*	16

(2)\* Gäller Hawle för kort fläns, T-rör och kort flänskryss

Standardiserade centreringshöjder

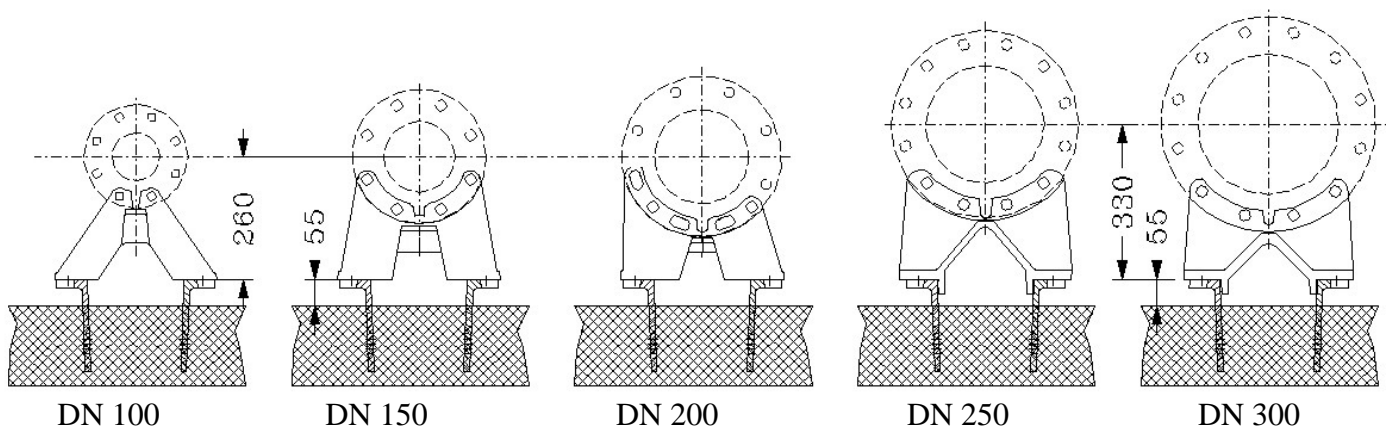

## Betäckning till rännstensbrunnar med frontgaller för 640

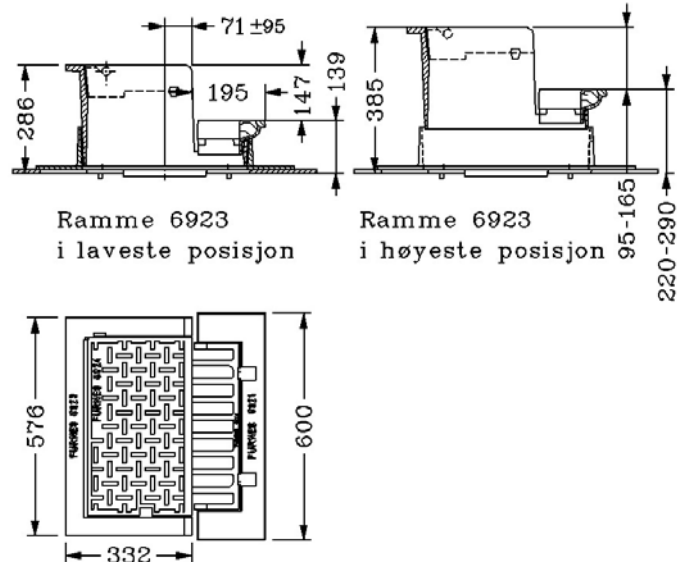

FURNES 6923/6924/6921/6922/6925

RSK nr	FURNES nr.	Benämning	Material	Klass	Vikt kg/stk.
703 23 22	6923sam	640 Flytande kjeftsluk för rak kantsten med frontgaller	Segjärn	C250	90

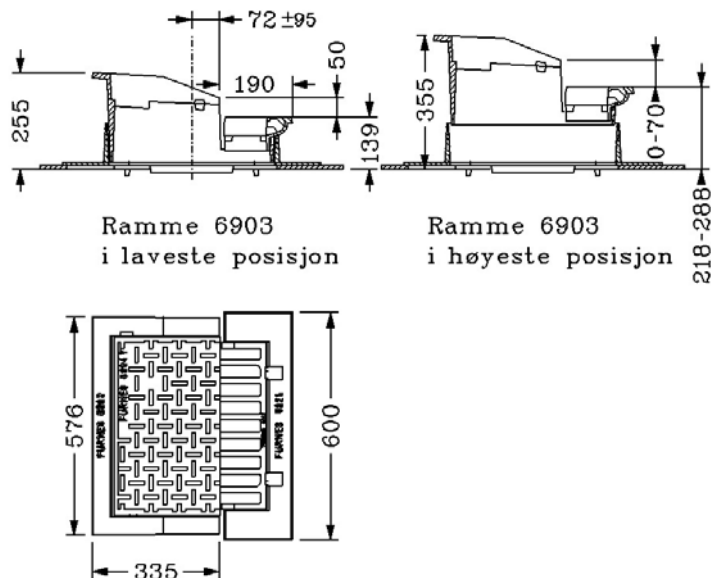

FURNES 6903/6904/6921/6922/6925

RSK nr	FURNES nr.	Benämning	Material	Klass	Vikt kg/stk.
703 23 20	6903sam	640 Flytande kjeftsluk för avfasad kantsten med frontgaller	Segjärn	C250	90
703 23 21	6903Tsam	640 Flytande kjeftsluk för avfasad kantsten med "tätt" frontlock	Segjärn	C250	93

## Betäckningar för nedstigningsbrunnar 600-640

### Lock

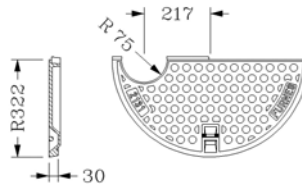

FURNES 2131



FURNES 2131  
Helt tett spetthull

RSK nr	FURNES nr.	Benämning	Material	Klass	Vikt kg/stk.
	2131	Delt lock med excentrisk hål	Segjärn	B125	29

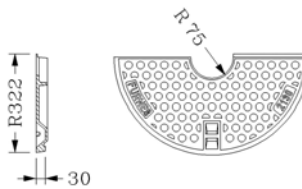

FURNES 2130



FURNES 2130  
Helt tett spetthull

RSK nr	FURNES nr.	Benämning	Material	Klass	Vikt kg/stk.
	2130	Delt lock för trafikljus	Segjärn	B125	28

## Betäckningar med lås till 400 brunnar

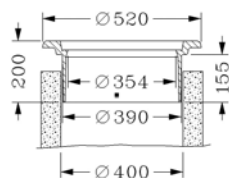

FURNES 6871



FURNES 6721/6721T

RSK nr	FURNES nr.	Benämning	Material	Klass	Vikt kg/stk.
703 22 62	6871/6721	400 flytande dagvattenbrunnsbet., lock med lås och öppet spethål	Gråjärn/ Segjärn	D400	49

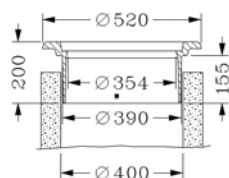

FURNES 6871

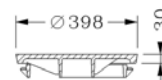

FURNES 6722

RSK nr	FURNES nr.	Benämning	Material	Klass	Vikt kg/stk.
703 22 63	6871/6722	400 flytande dagvattenbrunnsbet. med galler Genomströmningsarea 383cm <sup>2</sup>	Gråjärn/ Segjärn	D400	44,5

## Betäckningar med lås till 400 brunnar

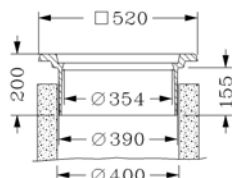
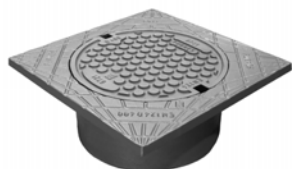

FURNES 6872 i 0400 betong



FURNES 6721/6721T

RSK nr	FURNES nr.	Benämning	Material	Klass	Vikt kg/stk.
703 62 64	6872/6721	400 flytande fyrkantsbet. för dagvattenbrunn, lock med lås och öppet spethål	Gråjärn/ Segjärn	D400	61

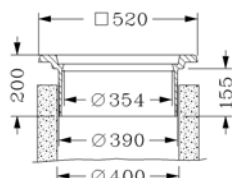

FURNES 6872 i 0400 betong



FURNES 6722

RSK nr	FURNES nr.	Benämning	Material	Klass	Vikt kg/stk.
703 22 65	6872/6722	400 flytande fyrkantsbet. för dagvattenbrunn, galler med lås Genomströmningsarea 383cm <sup>2</sup>	Gråjärn/ Segjärn	D400	56,5

## Betäckningar till 400 brunnar Ramar

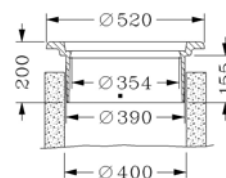

FURNES 6871

RSK nr	FURNES nr.	Benämning	Material	Klass	Vikt kg/stk.
703 73 18	6871	400 flytande ram Använd lock 6721/6721T och galler 6722	Gråjärn	D400	42

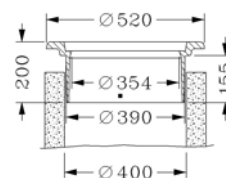

FURNES 6871

RSK nr	FURNES nr.	Benämning	Material	Klass	Vikt kg/stk.
703 73 19	6872	400 flytande fyrkantssram	Gråjärn	D400	42

## Betäckningar till 400 brunnar Lock med lås



Öppet



Tätt

FURNES 6721/6721T

RSK nr	FURNES nr.	Benämning	Material	Klass	Vikt kg/stk.
234 84 81	6721	400 lock med öppet spethål	Segjärn	D400	19
234 84 82	6721T	400 lock med tätt spethål	Segjärn	D400	19

## Galler med lås

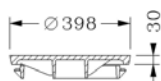

FURNES 6722

RSK nr	FURNES nr.	Benämning	Material	Klass	Vikt kg/stk
234 84 83	6722	400 galler med lås Genomströmningsarea 383cm <sup>2</sup>	Segjärn	D400	14,5

## Produkter som tillverkas för Uponor



U-125 lock i fyrkant U-125 ram



U-125 lock i rund U-125 ram



Kupolsil i rund U-125 ram



U-125 galler i fyrkant U-125 ram



U-125 galler i rund U-125 ram



L-63D lock i fyrkant ram



L-63D lock i rund ram



L-65 lock i ram



L-65 galler i ram



L-65 hög kupolsil i ram



L-65 låg kupolsil i ram



L-61 galler i ram



U-600 flytande ram med lock

[http://www.uponor.se/ifs/files/Uponor/swe/Presentation/Website/Brochures/brunnar\\_oktober2002.pdf](http://www.uponor.se/ifs/files/Uponor/swe/Presentation/Website/Brochures/brunnar_oktober2002.pdf)

*w w w . f u r n e s - h a m j e r n . s e*

Specialprodukter

03-01

## Betäckningar för nedstigningsbrunnar 600

### Flytande betäckningar

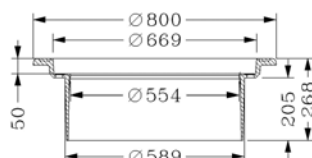

FURNES 2802

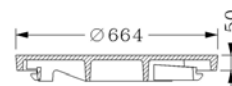

FURNES 2201P/TP

RSK nr	FURNES nr.	Benämning	Material	Klass	Vikt kg/stk
703 23 55	2802/2201P	600 flytande ram med slit-/ dämpring hög modell, lock med lås, öppet spethål	Segjärn	D400	101
703 23 56	2802/2201TP	600 flytande ram med slit-/ dämpring hög modell, lock med pilmönster, lås, tätt spethål	Segjärn	D400	101

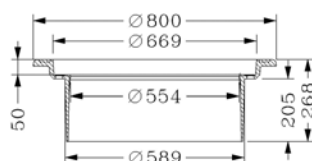

FURNES 2802



FURNES 2206

RSK nr	FURNES nr.	Benämning	Material	Klass	Vikt kg/stk
703 23 57	2802/2206	600 flytande ram med slit-/ dämpring hög modell och galler med lås Genomströmningsarea 1005cm <sup>2</sup>	Segjärn	D400	92



FURNES 2803

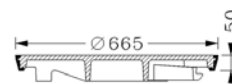

FURNES 2403TPS

RSK nr	FURNES nr.	Benämning	Material	Klass	Vikt kg/stk
703 23 75	2803/2403TPS	600 flytande ram hög modell och lock med pågjuten packning, tätt spethål	Segjärn	D400	94

## Betäckningar för nedstigningsbrunnar 600 Fasta betäckningar

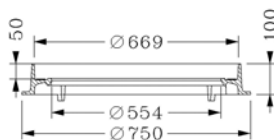

FURNES 2702

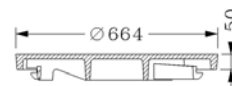

FURNES 2201P/TP

RSK nr	FURNES nr.	Benämning	Material	Klass	Vikt kg/stk.
703 23 72	2702/2201P	600 fast ram med slit-/ dämpning, H=100 och lock med pilmönster, lås, öppet spethål	Gråjärn	D400	86

## Betäckningar för nedstigningsbrunnar 600 Ramar

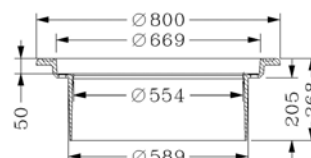

FURNES 2802

RSK nr	FURNES nr.	Benämning	Material	Klass	Vikt kg/stk.
703 72 53	2802	600 flytande ram med slit-/dämpring hög modell	Segjärn	D400	53
703 72 54	2802S	600 flytande slitsad ram med slit-/dämpring hög modell	Segjärn	D400	53

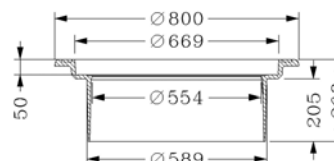

FURNES 2803

RSK nr	FURNES nr.	Benämning	Material	Klass	Vikt kg/stk.
703 22 41	2803	600 flytande ram hög modell	Segjärn	D400	54

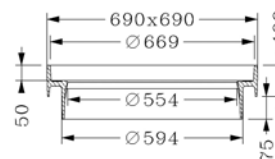

FURNES 2705

RSK nr	FURNES nr.	Benämning	Material	Klass	Vikt kg/stk.
703 21 76	2705	600 fast fyrkantssram med slit-/dämpring, H=100mm	Gråjärn	D400	57

## Betäckningar för nedstigningsbrunnar 600 Ramar

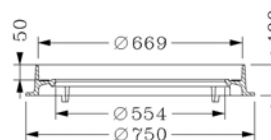

FURNES 2702

RSK nr	FURNES nr.	Benämning	Material	Klass	Vikt kg/stk.
703 21 78	2702	600 fast ram med slit-/dämpring, H=100mm	Gråjärn	D400	33

## Betäckningar för nedstigningsbrunnar 600 Lock

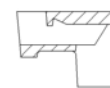
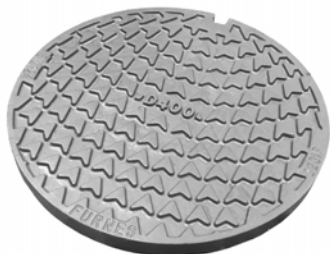

FURNES 2201P/TP

RSK nr	FURNES nr.	Benämning	Material	Klass	Vikt kg/stk.
703 21 65	2201P	600 lock med pilmönster, lås och öppet spethål	Segjärn	D400	48
703 21 66	2201TP	600 lock med pilmönster, lås och helt tätt spethål	Segjärn	D400	48

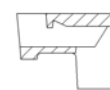
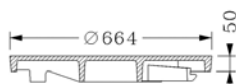

FURNES 2401T

RSK nr	FURNES nr.	Benämning	Material	Klass	Vikt kg/stk
703 22 99	2401T	600 lock med lås och tätt spethål	Segjärn	D400	50

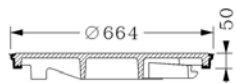

FURNES 2403T

RSK nr	FURNES nr.	Benämning	Material	Klass	Vikt kg/stk
703 22 37	2403T	600 lock med gummipackning, lås och helt tätt spethål	Segjärn	D400	44
703 21 71	8005	600 gummipackning för lock 2202, 2203 och 2403			

## Betäckningar för nedstigningsbrunnar 600 Lock

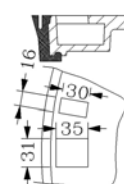
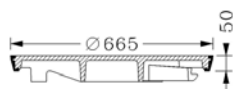

FURNES 2403TPS

RSK nr	FURNES nr.	Benämning	Material	Klass	Vikt kg/stk.
703 22 78	2403TPS	600 lock med pågjuten packning och lås med tätt spethål	Segjärn	D400	44

## Betäckningar för nedstigningsbrunnar 600 Galler

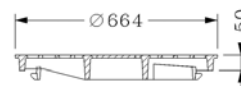

FURNES 2206

RSK nr	FURNES nr.	Benämning	Material	Klass	Vikt kg/stk.
703 22 18	2206	600 galler med lås Genomströmningsarea 1005cm <sup>2</sup>	Segjärn	D400	39

För ram 2802, 2802S, 2705 och 2702

*Specialprodukter*  
**Betäckningar för nedstigningsbrunnar 600**  
**Flytande betäckning**

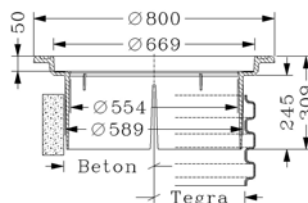

FURNES 2802HS

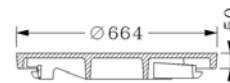

FURNES 2201P/TP

RSK nr	FURNES nr.	Benämning	Material	Klass	Vikt kg/stk.
703 23 37	2802HS/2201P	600 flytande ram med slit-/ dämpning hög modell och inspektions-spalter, lock med lås, öppet spethål	Segjärn	D400	111

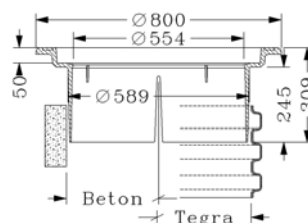

FURNES 2803HS

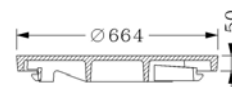

FURNES 2201P/TP

RSK nr	FURNES nr.	Benämning	Material	Klass	Vikt kg/stk.
703 23 38	2803HS/2201P	600 flytande ram hög modell och inspektions-spalter, lock med lås, öppet spethål	Segjärn	D400	109

*Specialprodukter*  
**Betäckningar för nedstigningsbrunnar 600**  
**Ramar**

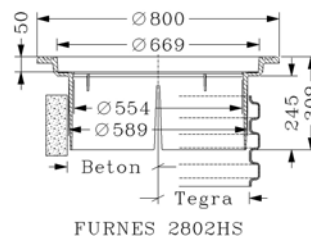

FURNES 2802HS

RSK nr	FURNES nr.	Benämning	Material	Klass	Vikt kg/stk.
703 23 36	2802HS	600 flytande slitsad ram med slit-/ dämpring hög modell	Segjärn	D400	63

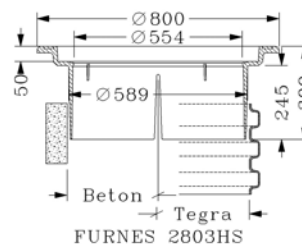

FURNES 2803HS

RSK nr	FURNES nr.	Benämning	Material	Klass	Vikt kg/stk.
703 23 35	2803HS	600 flytande slitsad ram hög modell	Segjärn	D400	61

*Specialprodukter*  
**Betäckningar för nedstigningsbrunnar 640**  
**Flytande betäckningar med 600 lock**

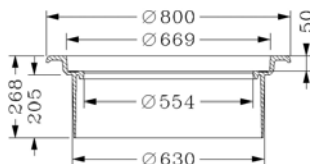

FURNES 2804

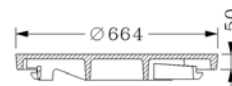

FURNES 2201P

RSK nr	FURNES nr.	Benämning	Material	Klass	Vikt kg/stk.
703 23 68	2804/2201P	640 flytande ram med slit-/dämpring och 600 lock m/pilmönster, lås och öppet spetthål	Segjärn	D400	106

*Specialprodukter*  
**Betäckningar för nedstigningsbrunnar 640**  
**640 ramar till 600 lock**



FURNES 2804

RSK nr	FURNES nr.	Benämning	Material	Klass	Vikt kg/stk.
703 22 42	2804	640 flytande ram med slit-/dämpning till 600 lock	Segjärn	D400	58

Hänvisar till lock och galler 600.